

H.264 FULL HD 1080P WIFI Vehicle Video Recorder User Manual



2018 FEB. V2.0



Safety Precautions

Dear Vacron user,

Appreciate for you purchase Vacron products. Please contact your local distributor if you meet any questions or need any assistance. We will offer you complete and in time service via a local distributor. However, we still have the rights to upgrade software and hardware without any kind notice beforehand. Please read this manual carefully before use of this product.

Installation Precautions

- Before installation, please ensure wires and cables connect correctly.
- Device has to install in a ventilated environment and the installation has to be guided or helped by any professional device installer.
- Please use a storage device that recommended by the manufacture, and purchase the storage device from the official purchase channel.
- Please contact local distributor and technical support service if you have any question and need any help during product usage

In Use Precautions

- Please avoid any solid or liquid drop into the inner components.
- Please do not disassemble the equipment for warranty issues. Please contact local dealers or the manufacturer for prompt service.
- Please remove the battery if remote control keeps idle for quite a long while.
- The equipment best connection is with ground wire in case of outdoor cameras connection or alarm I/O connection. This is to keep the DVR away from static electricity damage.

Surrounding

- Please have the DVR under the recommended temperature and set it away from the sun and heating source.
- Please keep this equipment away from the humid surrounding.
- Please keep this equipment away from the smoke and dust environment.
- Please avoid strong collision and do not drop the equipment.
- Please set this equipment in ventilation space, and do not block the ventilator of device.
- Please use the device under rated voltage and Amp.
- Please keep flammable objects away from the equipment.

Table of Contents

A.	Product Accessories.....	3
B.	Features	3
C.	Specifications	4
D.	Appearance/ Dimensions.....	5
E.	Installation diagram.....	6
F.	Micro SD Card	7
G.	Record / Stop record	8
H.	WiFi connection	9
I.	APP connection:	10
J.	Playback.....	17
K.	PC Player.....	18
L.	Data Backup.....	20
M.	SD Card	22
N.	Playback.....	26
O.	Screenshot tools	28
P.	Format / Restore SD card	29

A. Product Accessories

Please check every accessory we listed below, make sure everything is included in the product package before use. If you found anything is missing, please contact the local distributor.

Note: The product set does not come with a memory card, please purchase the memory card separately.

Standard Set:

1. DVR Host
2. Bracket holder with 4-meter power cable
3. 5V / 2A cigarette power adaptor

B. Features

- View angle approx. 110 ° · built-in microphone to record video and audio sync.
- H.264 image compress technology, which ensures image dose not distorted. Full HD video resolution. Support Micro SD card 64GB °
- Low power consumption and efficient heat dissipation, no build-in Lithium battery to prevent possible danger and heat explosion.
- Devices start recording automatically when the engine is on; the device will save file and turn off automatically when the engine is off.
- Built-in WIFI, capable to watch live video, playback and backup files by download APP in IOS or Android system
- Made in Taiwan, 1 year product warranty °

C. Specifications

Terms	Specifications
System	NTSC \ PAL
Image sensor	1/2.9" SONY CMOS Image Sensor
Resolution	1920(H)×1080(V)
Picture elements	2.12 Mega Pixel
Resolution	1080P
Synchronization	internal
Scanning system	2:1interlace
Low lux	0.1LUX
Noise	Min 58db
AGC	ON
AEX	Auto: (1/25NTSC)(1/25 PAL)sec TO 1/50,000 sec
BLC	Auto
MIC	Built-in high sensitivity microphone
Lens	Board Lens 3.3mm F1.8
View Angle	110° (Horizontal)/140° (Diagonal)/80° (vertical)
WLAN	IEEE802.11b/g/n, Wi-Fi compliant
Wi-Fi (Option)	WPA,WPA-PSK,WPA2,WPA2-PAK,WEP 64bit&128bit, IEEE802.11x,IEEE802.11i
SD card	Micro SD card 64GB
Power input	USB type A 5V /mount DC 5V 4meters USB
Power Consumption	400mA
Storage temp.	- 20° C ~ + 80°C
Working temp.	- 10° C ~ + 60°C
Dimension (L x W x D)	L64.03 x W33 x H66.46mm (mount includes)

Notes: The product specification is subject to change without prior notice

D. Appearance/ Dimensions

Dimension : mm

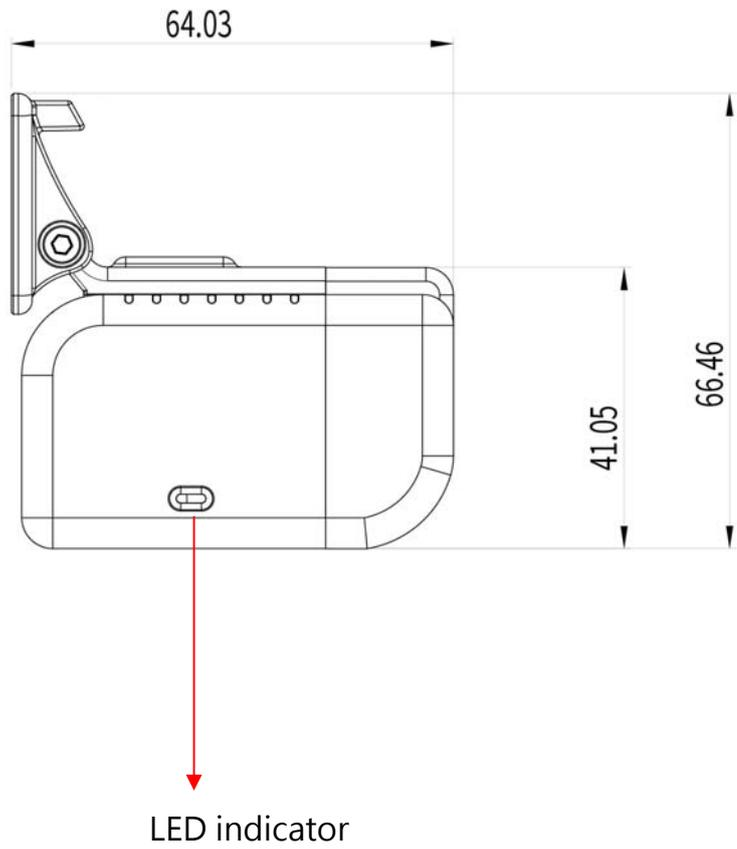
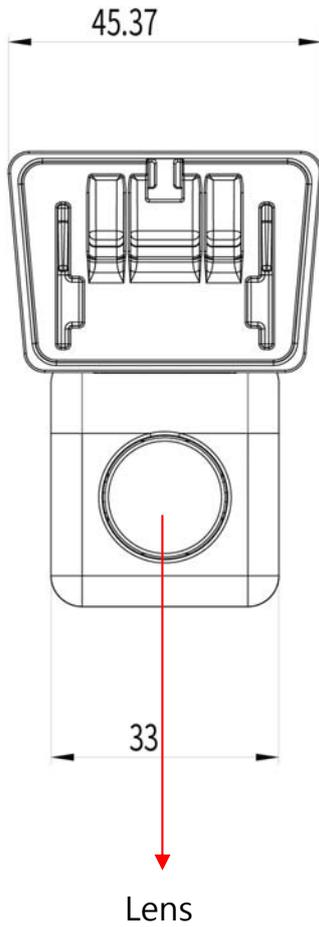

E. Installation diagram

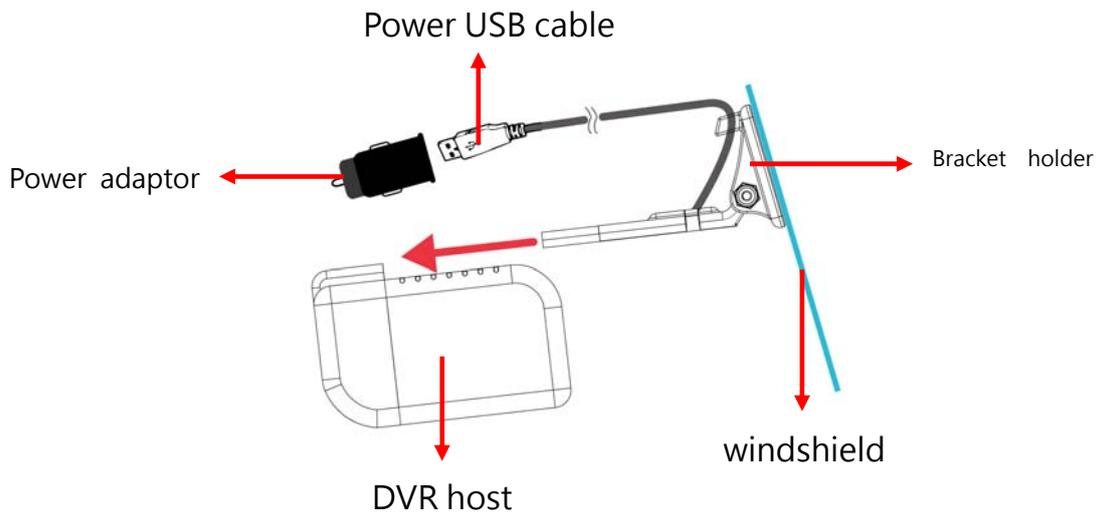
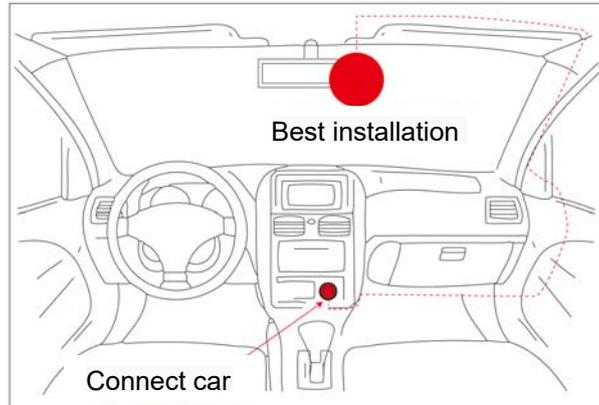

Install the device in windshield position. · connect the power USB cable to the power adaptor, and plug it in the cigarette adapter. When the engine turns on, the DVR starts recording. The DVR can be removed from the bracket holder if no uses.

F. Micro SD Card



1. SD card format

When the user to purchase a new memory card, or use their existing card, is required after the first card is formatted before use.



Attention

1. Backup the data before format the Micro SD Card.
2. Make sure if SD Card is on unlock mode before executing the format.
3. Please execute format as administrator if fail to format SD card which is on un-lock mode.
4. Suggest using class 10, 8GB above SD card
5. All memory disks have a limited lifespan. Please regularly watch videos on the PC and check the memory disk to ensure proper functioning.
6. Not support hot-plugging, please power off the device before removing the SD card.

G. Record / Stop record

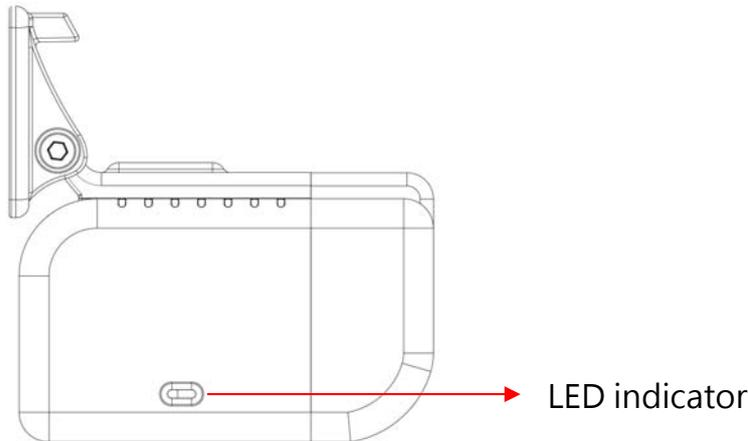

REC. Indicator

- Power on, around 15s, Red LED Flashing means continuous recording.
- RED LED is lighted constantly means systems error.
 1. Make sure if SD card is plugged.
 2. Verify SD cards health statues.



Attention

- (1). The device will not work properly without Micro SD Card.
- (2). Please format the SD card before use.
- (3). It takes around 60s for first power on with new a SD Card, during this period the RED LED is lighted constantly, after that the system will reboot, the RED LED will be flashing, it means system work properly.

WiFi indicator

- Green LED flashing means WIFI connected.

H. WIFI connection

- Search WIFI SSID
WLAN connection, SSID is DIRECT-SSID-xxxxxx as user ID.
- WIFI password: 12345678

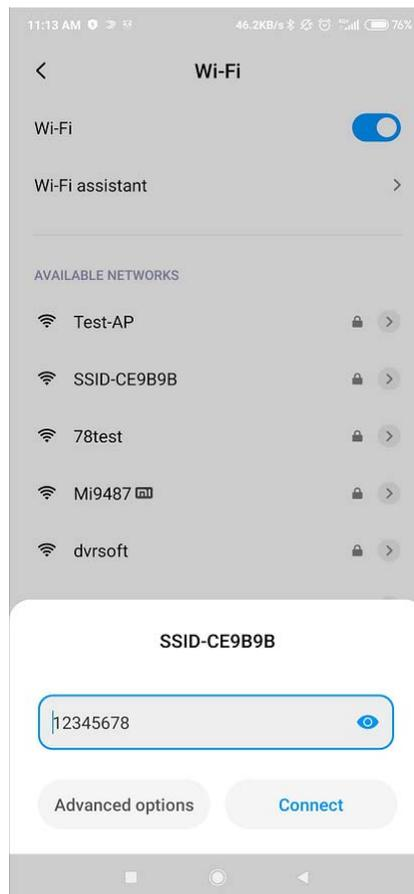

I. APP connection:

(a) QR Code download:

VACRON MOTO FOR IOS



VACRON MOTO FOR ANDROID



(b) Android:

1. Visit Google play store, search for "VACRON MOTO" and download
2. WLAN connection, type in 「DIRECT-SSID-XXXXXX」 as user ID, password as 「12345678.」
3. Open "VACRON MOTO", watch real-time video record by selecting real-time video
4. Select 「Playback:」 Capable play all video files that storages in SD card.
5. Select 「Download Video files,」 capable download video by date, time and channel for 1 minute.
6. Click "Save Record": Capable watch all records, Instant Record, Playback Record, and Downloaded Record.
7. Click " Video fragment ": watch the video fragment during play real time and playback video

APP main menu

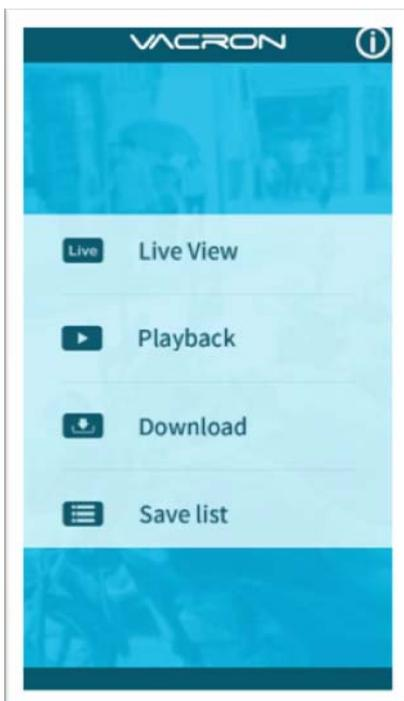

Real time image



Playback

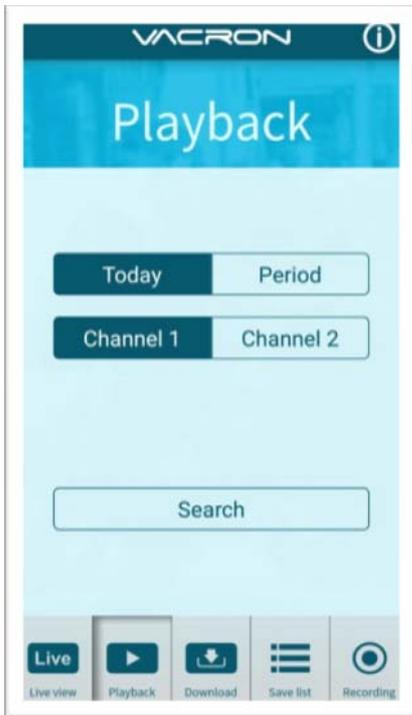

Playback:

1. Today: choose channel 1 or channel 2, and then press the Search button, it will show all video files that record in today. Select and playback any video record as your request.
2. Custom: Choose channel1 or channel2, meanwhile, setting date and period time, press search, it will show all video records that record during this range, select and playback any video record as your request.

File download

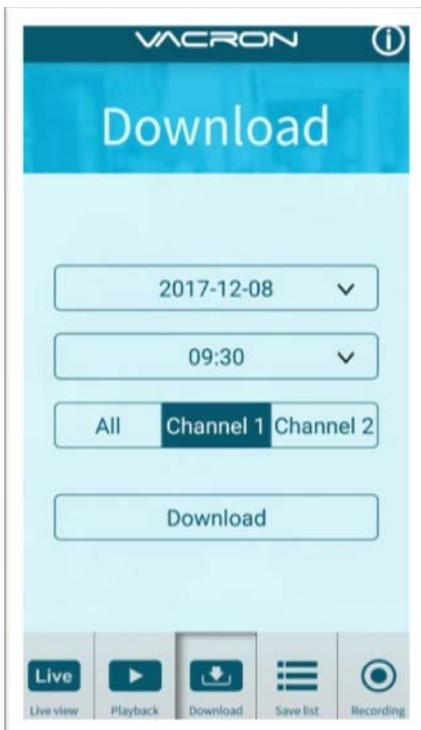

File Download

1. Select date, time point, and channel to download the video file (choose a suitable channel for a different device, it cannot download file when you choose an incorrect channel for your device.)
2. Press download to download the video file; the complete download time length depends on file size. Normally it takes approx. 1 to 2 minutes, the download format as MP4

Save list



Save list

1. All records: press and playback all downloaded records, which include a video clip of real-time video, playback video, download image.
2. Real-time: video fragment of real time video record, the file name ending with “L”.
3. Playback: video fragment of playback video record, file name ending with” PB”.
4. Download: file name ending with” D”

Video fragment



video fragment:

1. Press “Video fragment” during play real time video, the system will save a video fragment as MP4 format.
2. Press “Video fragment” during play back video records, the system will save a video fragment as MP4 format.

Setting

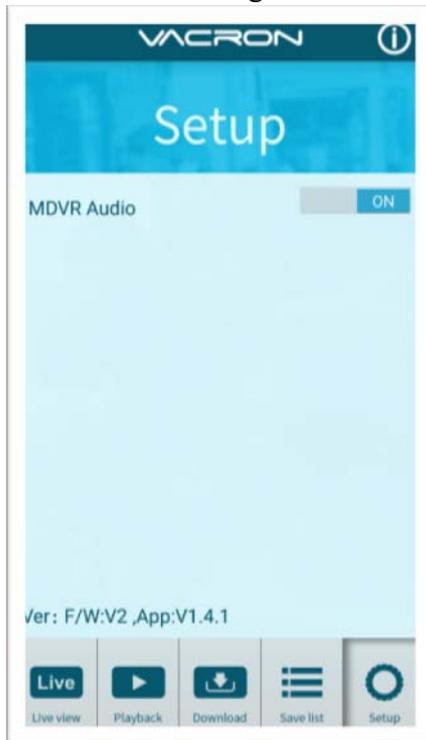

Setting:

Select microphone On/Off. (Require use with OBD)

Version:

1. F/W: Display the device current version
2. App: Display APP current version

(c) · IOS

1. Search and download “VACRON MOTO” in Apple store.
2. WLAN connection, type in 「DIRECT-SSID-XXXXXX」as user ID, password as 「12345678.」
3. Open “VACRON MOTO”, watch real time video record by selecting real time video
4. Select 「Playback:」Capable play all video files that storage in SD card.
5. Select 「Download Video files,」capable download video by date, time and channel for 1 minute.
6. Click "Save Record": Capable watch all records, Instant Record, Playback Record, and Downloaded Record.
7. Select 「Setting:」Capable turn On/Off microphone.
8. Select 「Snapshot:」Capable take snapshot.

APP main menu

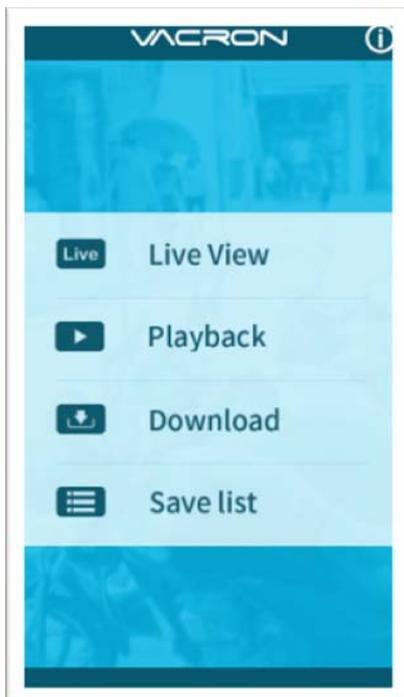

Real time image



Playback

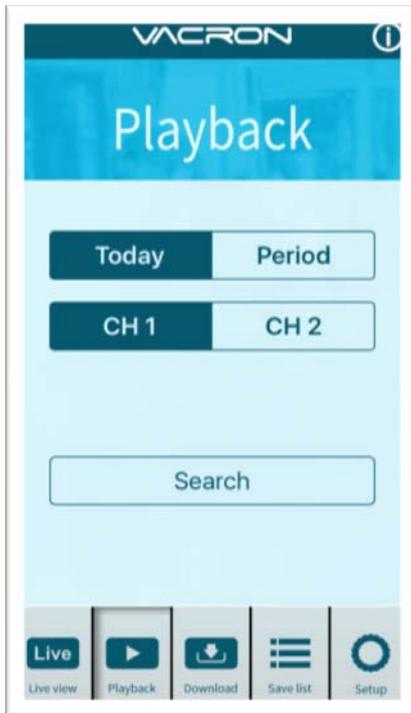

Playback:

1. Today: choose channel 1 or channel 2, and then press Search button, it will show all video files that record in today. Select and playback any video record as your request.
2. Custom: Choose channel1 or channel2, at meanwhile, setting date and time period, press search, it will show all video record that record during this range, select and playback any video record as your request.

File download



File Download

1. Select date, time point, and channel to download video file (choose suitable channel for different device, it cannot download file when you choose incorrect channel for your device.)
2. Press download to download video file; the complete download time length depends on file size. Normally, it takes approx. 1 to 2 minutes, the download format as MP4.

Save list



Save list

1. All records: press and playback all downloaded records, which include video clip of real time video, playback video, download image.
2. Real time: video fragment of real time video record, the file name ending with “L”.
3. Playback: video fragment of playback video record, file name ending with” PB”.
4. Download: file name ending with” D”

Setting



Setting:

Select microphone On/Off. (Require use with OBD)

**Attention**

1. Live image may be a delay caused by wireless signal connection error.
2. Remote control only uses for records that storage in device, record cannot be searched when the SD card had been overwritten.
3. Remember to close the WIFI connect with device after operation
4. It is recommended to check regularly with the use of the Laptop player to play the video. Make sure the video system maintains normal operations if OBD is not installed.

J. Playback

System will auto create Player.e57 link on SD Card. File name: Player.e57.

Use USB Card Reader and connect to PC for playback.

Click the link to download the Player to playback the video with specific file format.

K. PC Player

Run the player software by pressing , player o as following:

© To do this, the software should be installed DirectX 9.0 or above.

。

1. Viewer interface

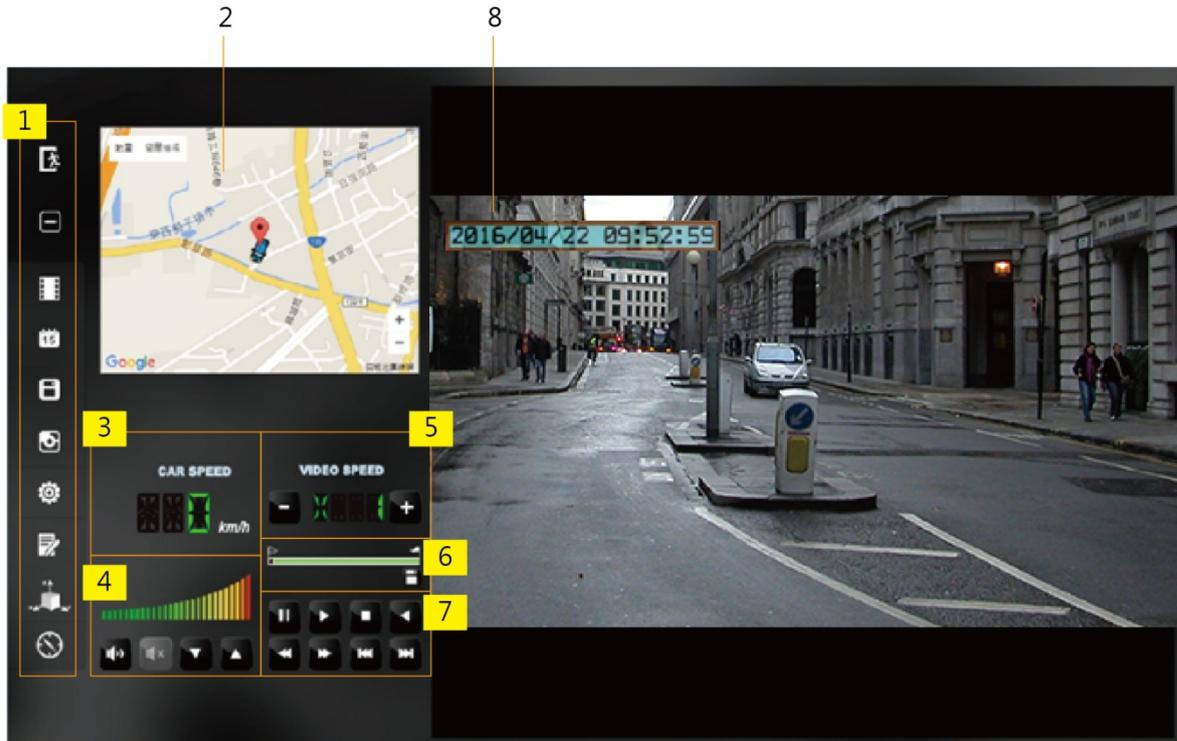

1	Function control interface
2	Not support
3	Not support
4	Volume
5	Play speed
6	Time bar/ File mark
7	Operation control interface
8	CAM

2. Function control interface

	Close
	Minimal window
	Select and playback file
	Calendar
	Backup
	Screen shot
	Setting
	Tool box, for format SD card, language

3. Play & Setting Icon Instruction

	Play previous file		Stop
	Play previous frame		Play
	Play backward		Play next frame
	Pause		Play next file

L. Data Backup

Save data from SD card to PC or other device.

Use PC player and click  to enter backup interface:

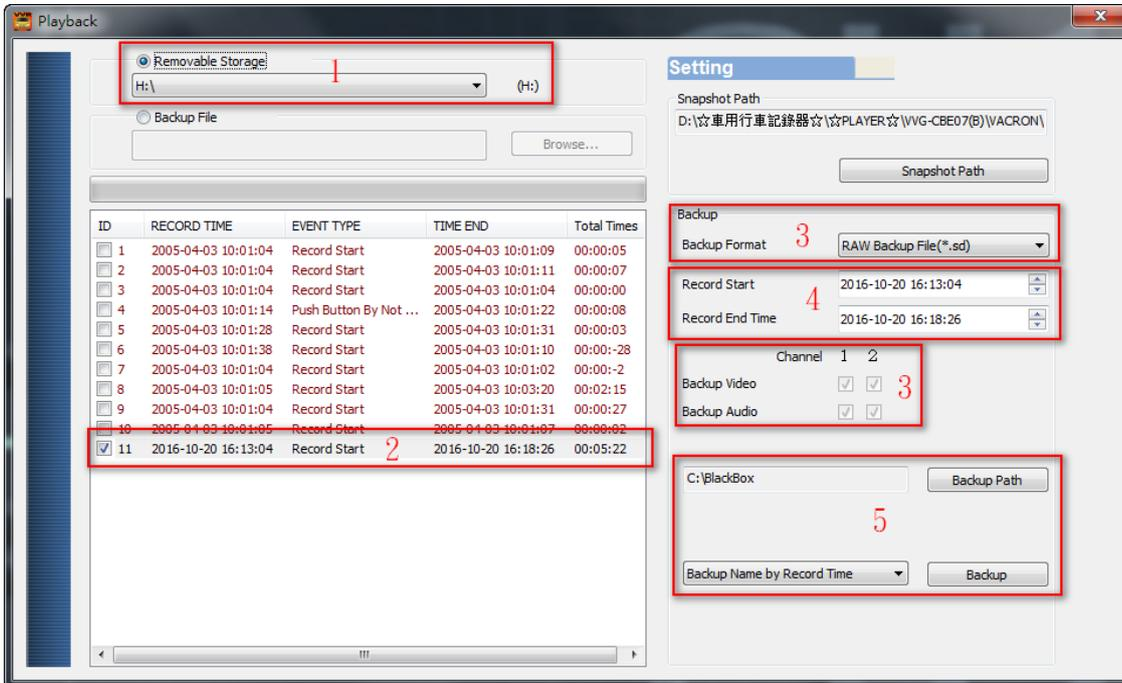

Step1. Choose SD card source:



Step2. Choose backup files_

<input type="checkbox"/>	9	2005-04-03 10:01:04	Record Start	2005-04-03 10:01:31	00:00:27
<input type="checkbox"/>	10	2005-04-03 10:01:05	Record Start	2005-04-03 10:01:07	00:00:02
<input checked="" type="checkbox"/>	11	2016-10-20 16:13:04	Record Start	2016-10-20 16:18:26	00:05:22

Step3. Choose backup data format_



Data format :

1. SD card original format (RAW)

 2014-05-27-18-10-03.sd	RAW file *.sd
--	---------------

2. AVI Format (*.avi)

 2014-05-27-18-11-07-Cam1.avi	Cam1 and Cam 2, *.avi file
--	----------------------------

Note: it is recommend backup to memory card in original format, the format will be containing GPS latitude and longitude, speed, recorded data such as G-SENSOR, if the backup date in *.AVI

Step4. Select the backup beginning time point

Record Start	2016-10-20 16:13:04	 
Record End Time	2016-10-20 16:18:26	 

Step5. Select the path and start to backup

<input type="text" value="C:\BlackBox"/>	<input type="button" value="Backup Path"/>
<input style="border: none; border-bottom: 1px solid gray; padding: 2px 5px; text-align: right; font-size: small; color: gray; cursor: pointer; background: none; width: 100%;" type="button" value="Backup Name by Record Time"/>	<input type="button" value="Backup"/>

M. SD Card

1. Before recording, insert SD Card into a card reader, and then insert the card reader to USB slot in PC, launch player and setting record format and displaying mode. After setting successfully, remove and insert SD card back to DVR.

Click  on the player to do the setting:

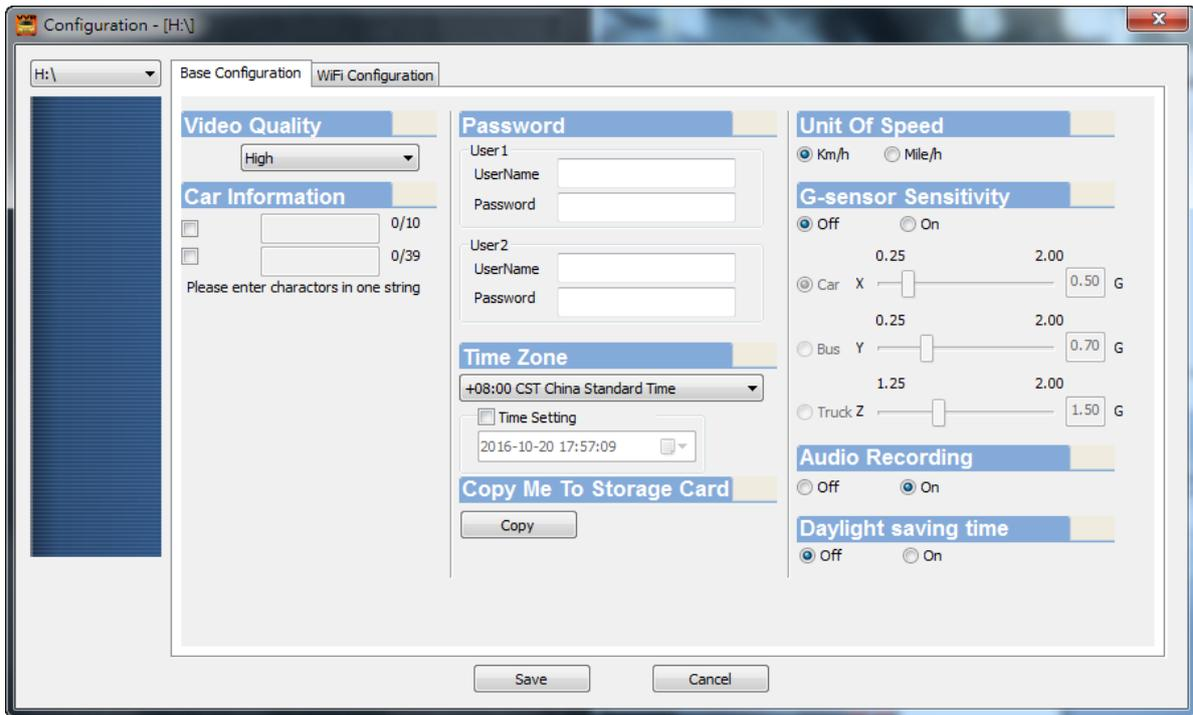

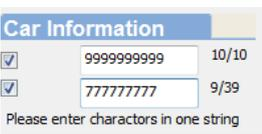
1	Video		Select the video quality: High/ Normal / Low
2	Vehicle information		The license plate number information can be inputted here, the film is easy to identify which vehicle is to record video record (only English letter and number acceptable.)
3	Password		Encrypted memory card for preventing other people get any information from this card. Set a password to 15 characters limited, for example 123456789123456 After setting the password, it is required to enter password to access the playback file, setting, formatting memory card.

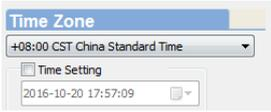
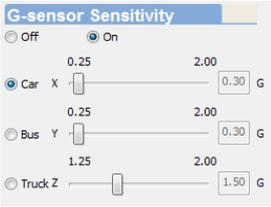
			★ Note: Please confirm the font case and record the password to avoid password forgetting.
4	Time zone		GMT (GPS automatic time correction)
5	Copy player to SD card		Copy player to SD card
6	G-sensor Sensitivity		Set for detecting the strength of vehicle collision, and condition to lead G-sensor sensitivity trigger and force recording.
7	Audio Recording		Audio recording. On: start audio recording / Off: stop audio recording
8	Daylight Saving Time		Set the daylight saving time: OFF/ON

2. WiFi connection

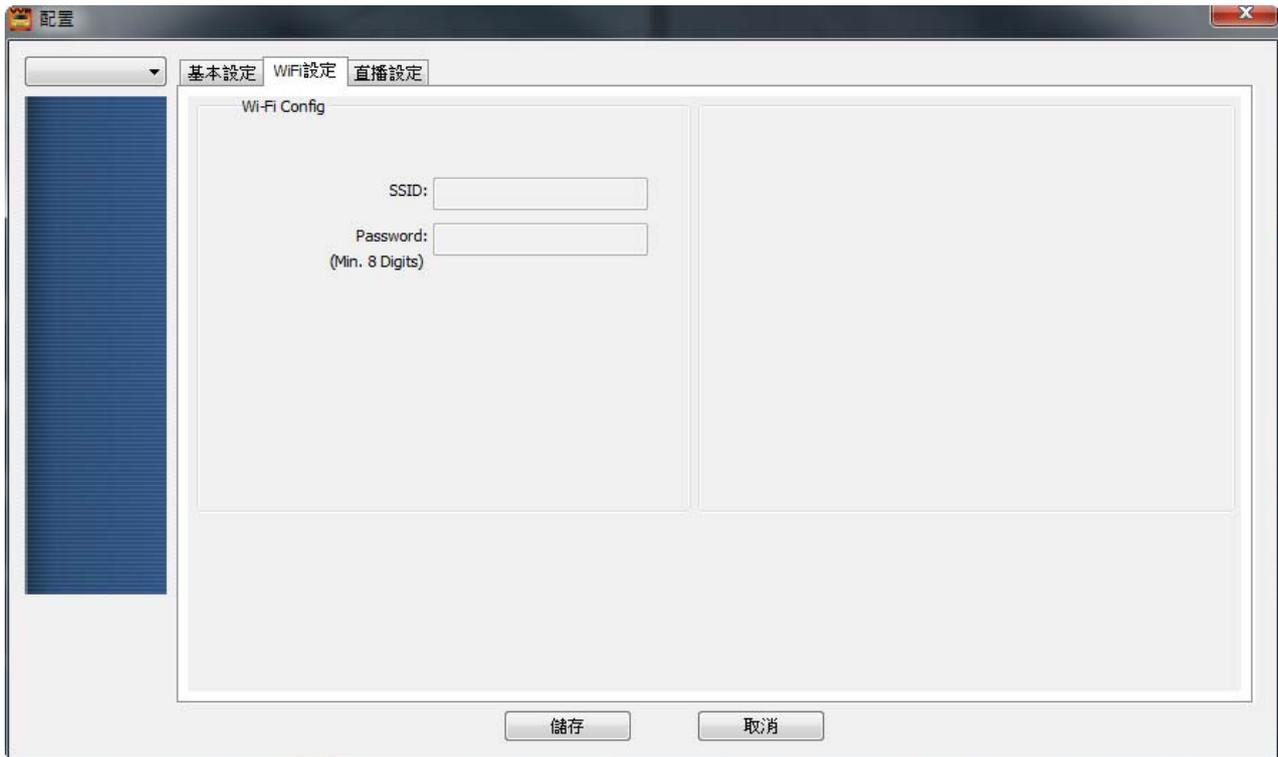

1	SSID	SSID: <input type="text"/>	SSID: type in WiFi connect ID °
2	Password:	Password: <input type="text"/> (Min. 8 Digits)	Password: WiFi connect password

3. Live Video Set Up

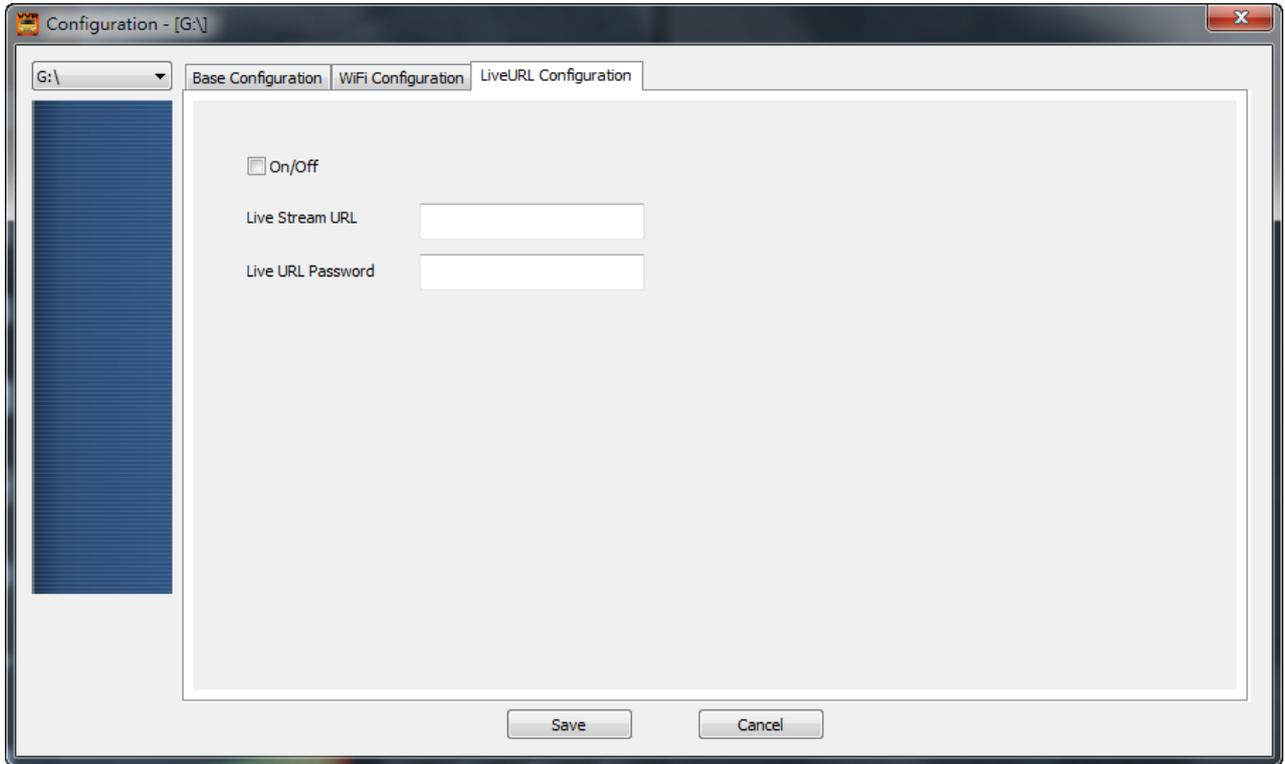

1	Live video function On/Off	<input type="checkbox"/> On/Off	Set up the live video function on or off
2	Live stream URL	Live Stream URL <input type="text"/>	Enter the live stream server URL
3	Live stream URL password	Live URL Password <input type="text"/>	Enter the stream URL/key

OUTUB example of live stream

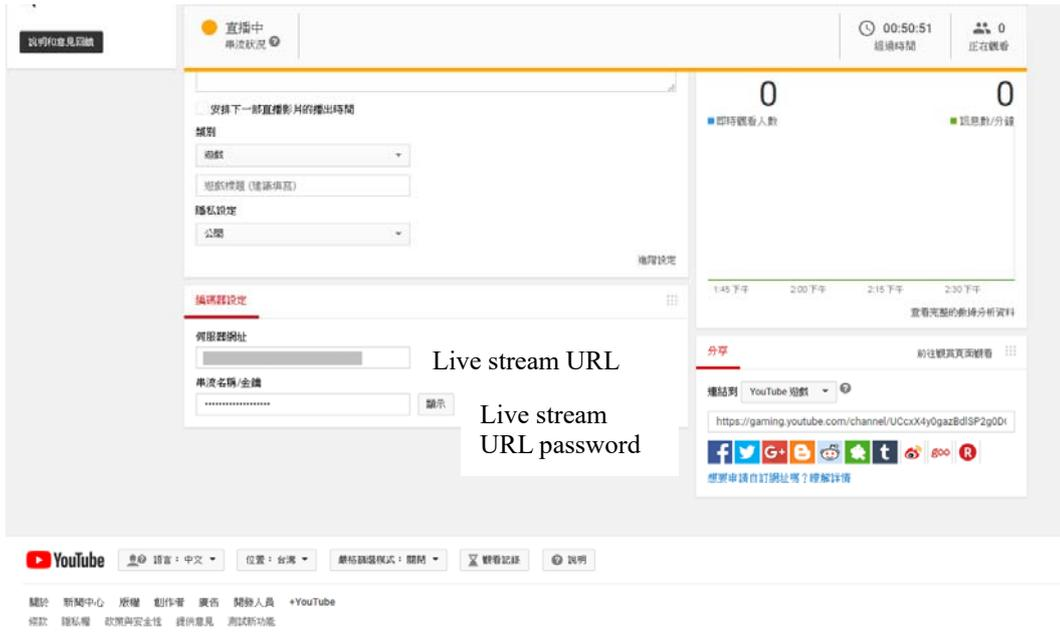

URL

N. Playback

Playback on PC player

Click  to enter playback mode

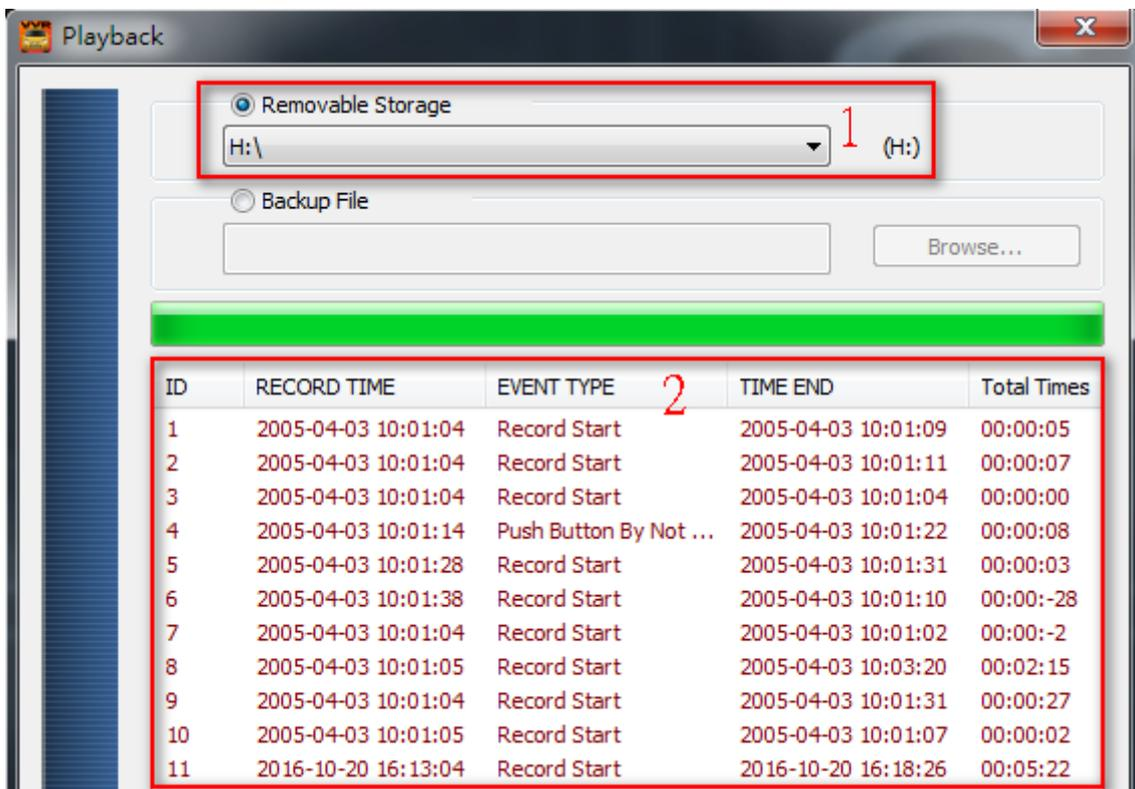

- (1) Select the path of the memory disk or a backup file on the hard disk.
- (2) Double click on the desired footage to play the file.

O. Screenshot tools

User can take a screenshot of the current frame by pressing 

Screenshot image will be saved at C: /Black Box, user can enter  to set image path. Data format is *.bmp

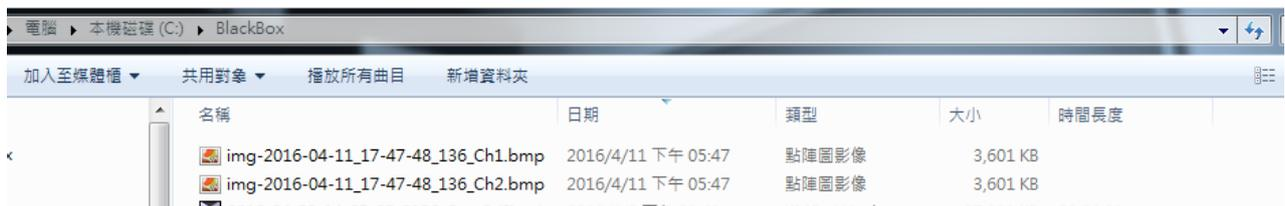
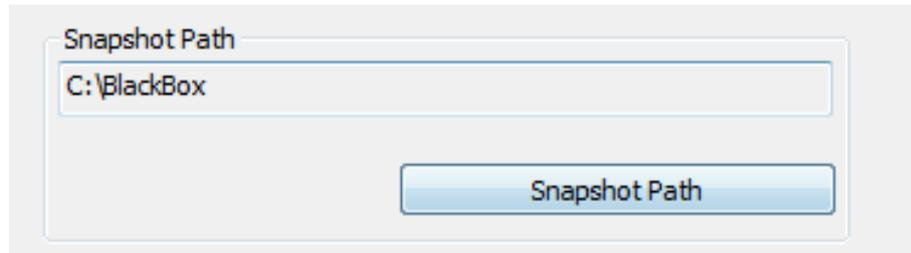

P. Format / Restore SD card

Q1. When does user need to format SD card?

When a user uses a brand new SD card, please format it before use.

★Note: This recording system cannot delete some specific video file, please backup video files that you need first before formatting.

Q2. When does a user have to restore SD card?

If you want to repurpose the memory disk for other uses (e.g. for computer or digital camera), you need to restore the disk first. All recorded data will be erased from the disk.

 **Attention**

(1). Unlock SD card before formatting ◦



(2). Please use “RUN AS ADMINISTRATOR” to format SD card

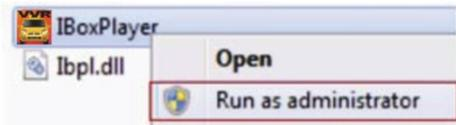

Q3. How to format/restore SD cards?

- (1). Put the SD card into a card reader, and then plug the card reader into your computer USB slot.
- (2). Play software , click  to enter formatting tool.

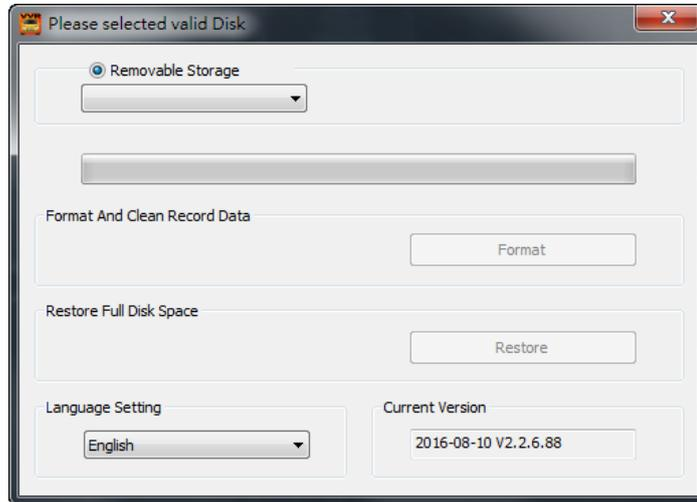

- (3). Select memory card position and choose format or restore SD card as user's requirement.

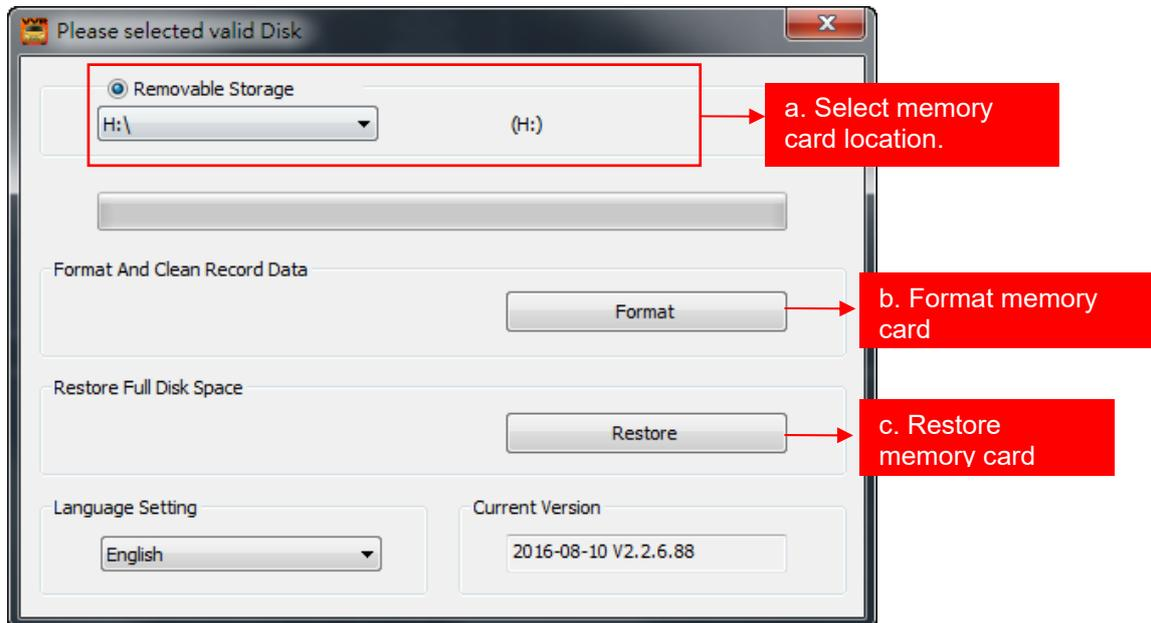

- (4). After SD card is formatted or restored, it can be used as the user's requirement.



More information about products

Please visit our website

<http://www.vacron.com.tw>

Made in Taiwan
